



KONICA MINOLTA

New Auto Mode increases accuracy at low luminance levels

# CHROMA METER CS-200

Suitable for measurement of optical devices such as LCDs, PDPs, organic ELs, FEDs and LEDs.

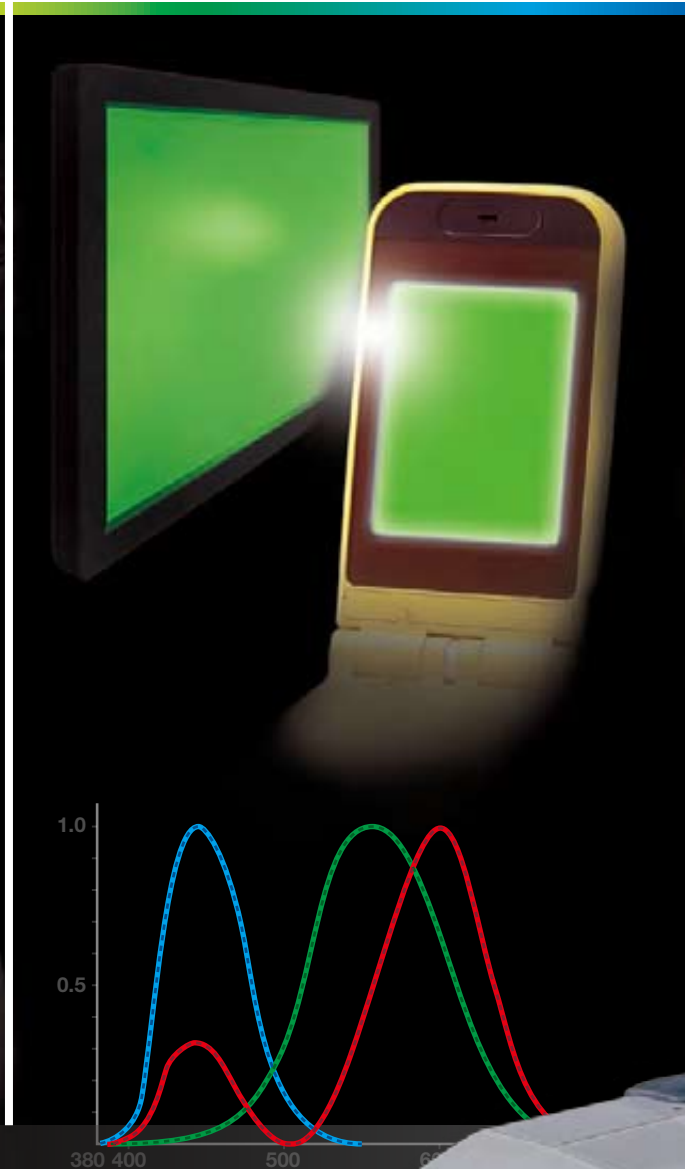

*High-Accuracy Luminance & Chromaticity Measurement Comparable to Many Spectroradiometers*



The essentials of imaging

# Performance Comparable to Many Spectroradiometers Ease of Use and Simplicity Equal to Tristimulus Meters

The technological innovation of displays such as FPDs and LCDs as well as LED products in recent years requires high-quality production, resulting in the need for accurate measuring instruments. The CS-200 is a new type of colorimeter achieving high accuracy while maintaining the simple operation of tristimulus-type colorimeters.

Three selectable angles of 1°, 0.2°, and 0.1° make it easy to measure large and very small objects in a wide measuring range from low luminance of 0.01 cd/m<sup>2</sup> to high luminance of 20,000,000 cd/m<sup>2</sup> (with a measuring angle of 0.1°).

The CS-200 can be used for luminance and chromaticity measurement of various optical devices such as displays like LCDs, PDPs, organic ELs and FEDs, as well as light sources such as LEDs and lamps.

## Accurate measurement

Konica Minolta's newly-developed spectral fitting method enables luminance and chromaticity measurement of single colors in various displays with an accuracy comparable to many spectroradiometers.

### New Auto Mode

#### Wide measuring range from low to high luminance

- The new Auto Mode adjusts the measurement speed according to the luminance of the measurement subject.
- Measurement is available from a low luminance of 0.01 cd/m<sup>2</sup> to a high luminance of 20,000,000 cd/m<sup>2</sup> (with a measuring angle of 0.1°).
- Use of the spectral fitting method and precise analog circuitry achieves stable measurement even for low luminance.

#### Compact and lightweight. Battery power is also possible.

- The compact, lightweight and stylish body allows hand-held operation. The CS-200 can be operated with either four AA batteries (battery indicator function provided) or a special AC adapter.

Measurement button

Finder and Diopter adjustment ring

Objective lens and Focus adjustment ring

Hand strap

LCD screen

Power switch

Measuring angle selector

USB connector

AC adapter input terminal

### Additional Functions

- Measurements can be synchronized with the display device by numerical input of the frequency.
- Selectable measurement speed (AUTO, LTD. AUTO, MANU, superFAST, FAST, SLOW and superSLOW)
- Large LCD display with backlight
- USB 1.1 communication
- Data storage: 101 measured values (9-letter ID assignment possible) and 20 reference values
- User calibration: 20 channels

### Selectable measuring angle

- While checking the actual subject, you can select the measuring angle easily according to the application (1°, 0.2° and 0.1°).
- The aperture mirror eliminates misalignment between the finder target and the actual measuring spot, ensuring accurate aiming.



# "Spectral fitting method" for accurate luminance & chromaticity measurement.

Konica Minolta's newly-developed spectral fitting method provides tristimulus values (XYZ = red, green, blue) with significantly higher accuracy than that of conventional tristimulus colorimeters. This is achieved by using the output from 40 sensors to calculate the spectral response corresponding to human eye sensitivity (CIE 1931 color-matching functions).

The CS-200 uses 40 sensors for sensitivity covering the entire visible region and multiplies each sensor output by appropriate coefficients. This adjusts the spectral response of the instrument to close to the CIE 1931 color-matching functions.

In addition to the 2° Standard Observer, the 10° Standard Observer (for object-color measurements) can also be selected, which is impossible with conventional tristimulus colorimeters.

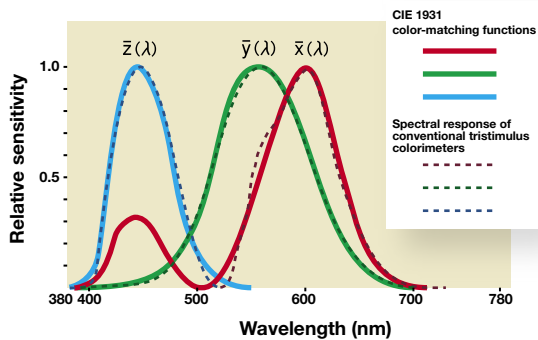

CIE 1931 color-matching functions and spectral response of a conventional tristimulus colorimeter

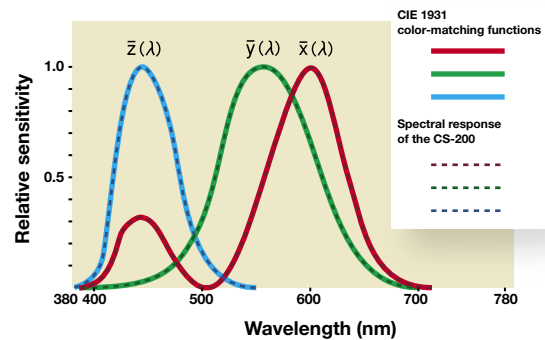

CIE 1931 color-matching functions and spectral response of the CS-200

## KONICA MINOLTA's Chroma Meter for accurate light-source measurement allows building of a color management network both internally and externally.

### In R&D and design departments

There is no need for calibration work to determine a value of each light source by using a reference spectroradiometer. For displays like LCDs or organic ELs in particular, user calibration for the reference panel using a spectroradiometer can be eliminated \*1.

\*1 If higher accuracy is required, user calibration can be used.

### In quality management and incoming inspection departments

Since individual errors are minimized compared to conventional tristimulus colorimeters, the inspection of various devices such as panels does not require individual error correction.

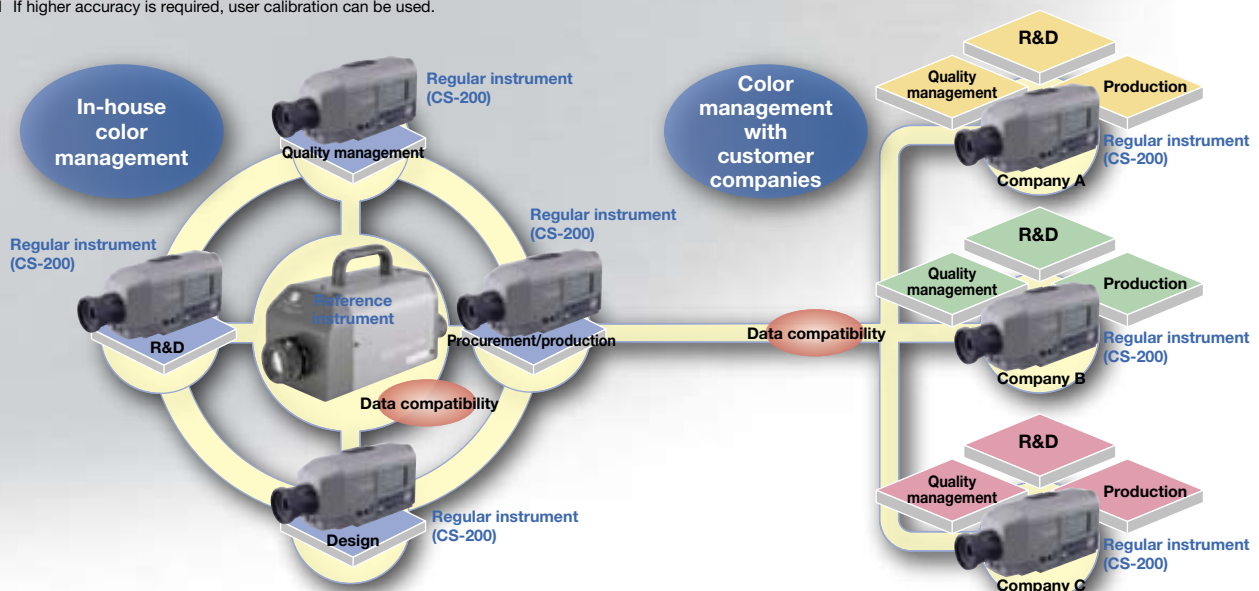



# Applications



## 1° aperture

For measurement of general-size areas such as medium and large displays

- LCD, PDP, or EL display panels
- LCD panels of mobile phones or digital cameras
- Light sources such as lamps or fluorescent-tube backlights
- Radar or other instrument panels in aircraft cockpits
- Large outdoor display screens

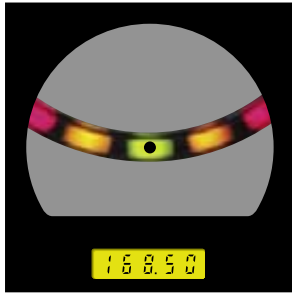

## 0.2° aperture

For measurement of small areas such as product LEDs

- Sub-display of mobile phones
- Car audio equipment
- Automobile instrument panels

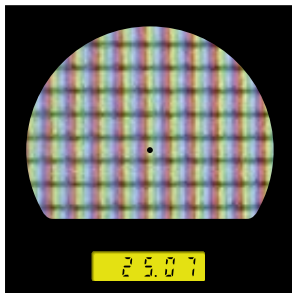

## 0.1° aperture

For measurement of very small areas or of a distant light source

- Pixels of a PDP or LCD
- Cold cathode tube
- Automobile lamps
- Signal lights



## Evaluation applications

Evaluation of the luminance and chromaticity of light sources

Evaluation of luminance and chromaticity uniformity

Contrast evaluation

$\gamma$ -characteristic evaluation

Simple measurement of object colors

(The optional white calibration plate is required.)



## Measuring distance and measuring area

(Unit: mm)

	Minimum measuring area			Maximum measuring area			Minimum measuring distance			Maximum measuring distance			Measuring area at 500 mm			Measuring area at 1000 mm		
	1°	0.2°	0.1°	1°	0.2°	0.1°	1°	0.2°	0.1°	1°	0.2°	0.1°	1°	0.2°	0.1°	1°	0.2°	0.1°
Without a Close-Up Lens	4.7	1.0	0.5	∞	∞	∞	296			∞			φ 8.5	φ 1.7	φ 0.9	φ 17.7	φ 3.6	φ 1.8
Close-up lens No. 122	2.2	0.5	0.3	4.6	1.0	0.5	128			240			—	—	—	—	—	—
Close-up lens No. 107	0.8	0.2	0.1	1.1	0.3	0.2	43			52			—	—	—	—	—	—

\* Measuring distance is the distance from the front edge of the metal lens barrel or close-up lens ring.

## Data Management Software CS-S10w Standard (Standard accessory)

CS-S10w Standard Edition allows users to control the CS-200 with a PC to display the list of measured data or to transfer the data to spreadsheet software.

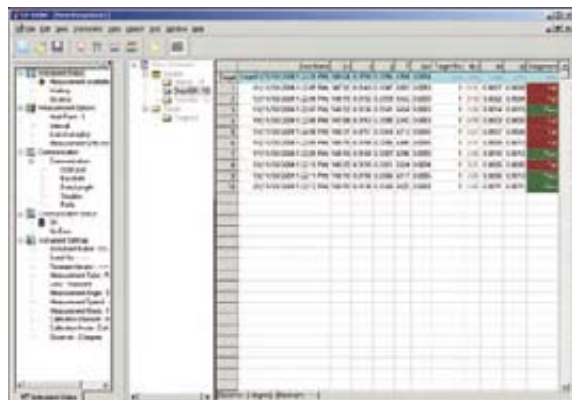

List display

### <Functions common to Standard and Professional Editions>



Interval and average measurements

- Color space** :  $L_v \times y$ ,  $L_v u' v'$ ,  $L_v T\Delta uv$   
XYZ, dominant wavelength  
Object color mode
- Mode selection** : Normal mode  
Interval measurement  
User calibration
- Instrument control** : Average measurement  
Interval measurement  
User calibration
- Data management** : Reading and saving files  
Data management with folders
- Data evaluation** : Observer/Illuminant settings  
Statistics display for each folder  
Box tolerance setting

## Data Management Software CS-S10w Professional (Optional accessory)

In addition to the functions of Standard Edition, optional CS-S10w Professional Edition enables various data management, analysis and evaluation functions useful for R&D or quality control.

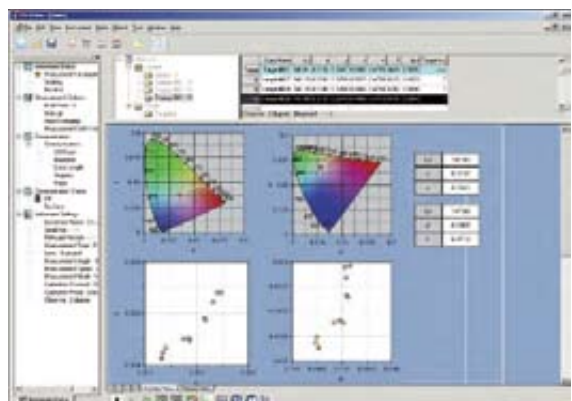

Template showing xy and u'v' chromaticity diagrams

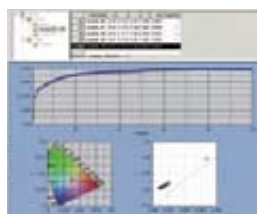

Trend graph display

### <Functions available only with Professional Edition>

- Mode selection** : Contrast mode  
RGB mode  
RGB & contrast mode
- Data management** : Creating, saving and loading templates (customizable design/layouts for various graphs)  
Various graph displays

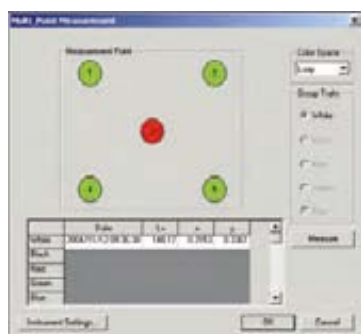

Multiple-point measurement

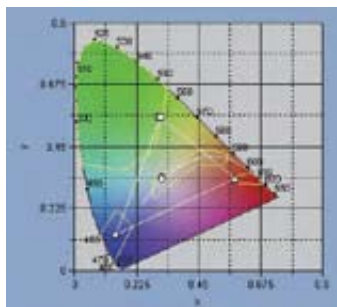

Pass/fail judgment using polygon tolerance (limit values) setting on a chromaticity diagram

- Data evaluation** : Multiple-point measurement, uniformity display, contrast display and polygon tolerance setting for display evaluation
- Other** : Creating reports in customizable screen layouts

### System requirements (common to Standard and Professional Editions)

<b>OS</b>	Windows®2000 Professional SP4, Windows®XP Professional SP2, Windows®XP Professional x64 Edition
<b>CPU</b>	Pentium®III 600 MHz equivalent or higher (recommended)
<b>Memory</b>	128 MB min. (256 MB or more recommended)
<b>Hard disk</b>	60 MB or more space required for installation
<b>Display</b>	1024 X 768, 256 colors or more
<b>Other</b>	CD-ROM drive, USB port

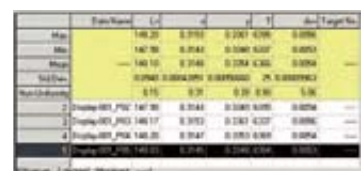

Uniformity list

- Windows® is a trademark of Microsoft Corporation in the USA and other countries.
- Pentium® is a trademark of Intel Corporation in the USA and other countries.

## CS-200 specifications

<b>Item</b>	CS-200		
<b>Measurement range</b>	0.01 - 200,000 cd/m <sup>2</sup> (Measuring angle 1°)		
	0.01 - 5,000,000 cd/m <sup>2</sup> (Measuring angle 0.2°)		
	0.01 - 20,000,000 cd/m <sup>2</sup> (Measuring angle 0.1°)		
<b>Accuracy</b> (Measuring angle 1°) #1 (Temperature: 23°C±2°C, Relative humidity: 65% max.)	150 cd/m <sup>2</sup> (for Illuminant A)	L <sub>v</sub> ±2 % ±1digit	xy ±0.002
	0.01-0.5 cd/m <sup>2</sup> (for Illuminant A)	L <sub>v</sub> ±0.02 cd/m <sup>2</sup> ±1digit	---
	0.5-1 cd/m <sup>2</sup> (for Illuminant A)	L <sub>v</sub> ±0.02 cd/m <sup>2</sup> ±1digit	xy ±0.007
	1-10 cd/m <sup>2</sup> (for Illuminant A)	L <sub>v</sub> ±2 % ±1digit	xy ±0.004
	10-200,000 cd/m <sup>2</sup> (for Illuminant A)	L <sub>v</sub> ±2 % ±1digit	xy ±0.003
	5000 cd/m <sup>2</sup> (for Illuminant A)	color filter (R, G, B)	xy ±0.006
<b>Repeatability</b> (Measuring angle 1°) #2	0.01-1 cd/m <sup>2</sup> (for Illuminant A)	L <sub>v</sub> 0.01 cd/m <sup>2</sup> +1digit	--- (2σ/AUTO)
	1-2 cd/m <sup>2</sup> (for Illuminant A)	L <sub>v</sub> 0.5 % +1digit	xy 0.002 (2σ/AUTO)
	2-4 cd/m <sup>2</sup> (for Illuminant A)	L <sub>v</sub> 0.5 % +1digit	xy 0.001 (2σ/AUTO)
	4-8 cd/m <sup>2</sup> (for Illuminant A)	L <sub>v</sub> 0.5 % +1digit	xy 0.0005 (2σ/AUTO)
	8-200,000 cd/m <sup>2</sup> (for Illuminant A)	L <sub>v</sub> 0.1 % +1digit	xy 0.0004 (2σ/AUTO)
<b>Measurement time</b>	AUTO (Automatically set between approx. 1s and 60s)		
	LTD.AUTO (Automatically set to approx. 1s or 3s)		
	Super-FAST (approx. 0.5 sec/meas.)	FAST (approx. 1 sec/meas.)	
	SLOW (approx. 3 sec/meas.)	Super-SLOW (approx. 12 sec/meas.)	
<b>Measurement method</b>	Spectral method, Grating + linear photo diode array		
<b>Measuring angle</b>	1°, 0.2°, 0.1° (switchable)		
<b>Minimum measuring area</b>	0.5 mm		
<b>Minimum measuring distance</b>	0.1 mm (close up lens)		
<b>Observer</b>	296 mm (Distance from front edge of metal lens barrel)		
<b>Observer</b>	2/10 degrees		
<b>Color space</b>	L <sub>v</sub> x y, L <sub>v</sub> u' v', L <sub>v</sub> TΔuv, XYZ, dominant wavelength		
<b>Measurement synchronization setting range</b>	Vertical synchronization frequency : 40.00 to 200.00Hz		
<b>Interface</b>	USB 1.1		
<b>Power source</b>	AC adapter or 4 AA-Size Batteries		
<b>Battery life</b>	Approx. 3 hours (continuous measurement / Fast mode / AA-size alkaline cells)		
<b>Size</b>	95 mm (W) x 127 mm (H) x 334 mm (L)		
<b>Weight</b>	1.8 kg (without battery)		
<b>Operating temperature /humidity range</b>	0°C to 40°C, relative humidity 85% or less (at 35°C) with no condensation		
<b>Storage temperature /humidity range</b>	0°C to 45°C, relative humidity 85% or less (at 35°C) with no condensation		

#1 23°C ±2°C L<sub>v</sub> = 0.01-10 cd/m<sup>2</sup>, SLOW, average of 30 measurements

L<sub>v</sub> = 10 cd/m<sup>2</sup> and higher, SLOW, average of 10 measurements

#2 At 0.2° measuring angle, the amount of received light is approx. 1/25 of that for 1°.

Therefore, the repeatability becomes the same as that for 1° with 25 times lower luminance.

At 0.1° measuring angle, the amount of received light is approx. 1/100 of that for 1°.

Therefore, the repeatability becomes the same as that for 1° with 100 times lower luminance.



Certificate No.: YKA 0937154  
Registration Date: March 3, 1995



Certificate No.: JQA-E-80027  
Registration Date: March 12, 1997

### SAFETY PRECAUTIONS



For correct use and for your safety, be sure to read the instruction manual before using the instrument.

- Always connect the instrument to the specified power supply voltage. Improper connection may cause a fire or electric shock.
- Be sure to use the specified batteries. Using improper batteries may cause a fire or electric shock.

**KONICA MINOLTA SENSING, INC.**  
Konica Minolta Sensing Americas, Inc.  
Konica Minolta Sensing Europe B.V.

Osaka, Japan  
New Jersey, U.S.A.  
European Headquarter /BENELUX  
German Office (International)  
German Office (Germany)  
French Office  
UK Office  
Italian Office  
Swiss Office  
Nordic Office  
Austrian Office  
Polish Office

**Konica Minolta (CHINA) Investment Ltd.**  
SE Sales Division  
SE Beijing Office  
SE Guangzhou Office

**Konica Minolta Sensing Singapore Pte Ltd.**

**KONICA MINOLTA SENSING, INC.** Seoul Office

**Phone** : 888-473-2656(in USA), 201-236-4300(outside USA)  
Nieuwegein, Netherland  
Langenhagen, Germany  
München, Germany  
Roissy CDG, France  
Milton Keynes, United Kingdom  
Milan, Italy  
Dietikon, Switzerland  
Västra Frölunda, Sweden  
Wien, Austria  
Warszawa, Poland  
Shanghai, China  
Beijing, China  
Guangzhou, China  
Singapore  
Seoul, Korea

**Fax** : 201-785-2480  
+31(0)30 248-1211  
+49(0)511 7404-807  
+49(0)89 630267-67  
+33(0)1 493-84771  
+44(0)1908 540-629  
+39(0)23 9011219  
+41(0)43 322-9809  
+46(0)31 474945  
+43(0)1 87882-431  
+48(0)22 56033-01  
+86-021-5489 0205  
+86-010-8522 1241  
+86-020-3826 4223  
+65 6560-9721  
+65 6560-9729

Addresses and telephone/fax numbers are subject to change without notice. For the latest contact information, please refer to the KONICA MINOLTA SENSING Worldwide Offices web page (link below).

©2004 KONICA MINOLTA SENSING, INC.

## System configuration

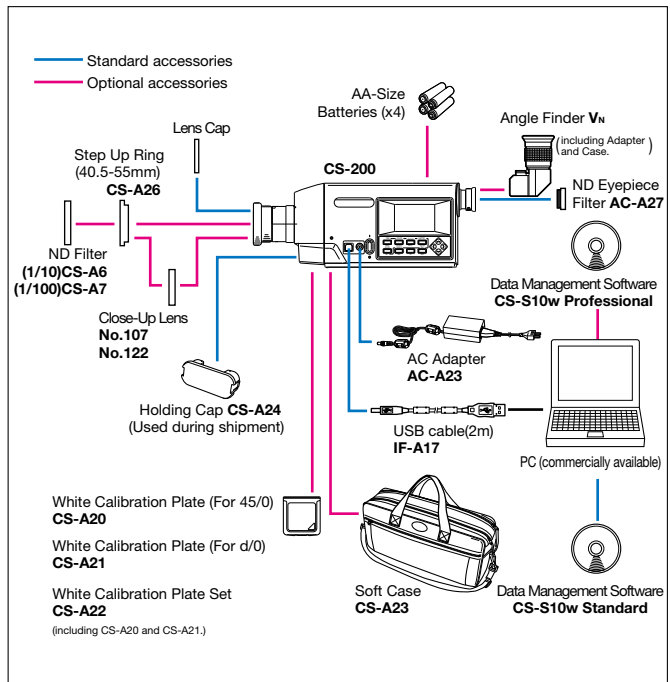

## Outer dimensions (Unit: mm)

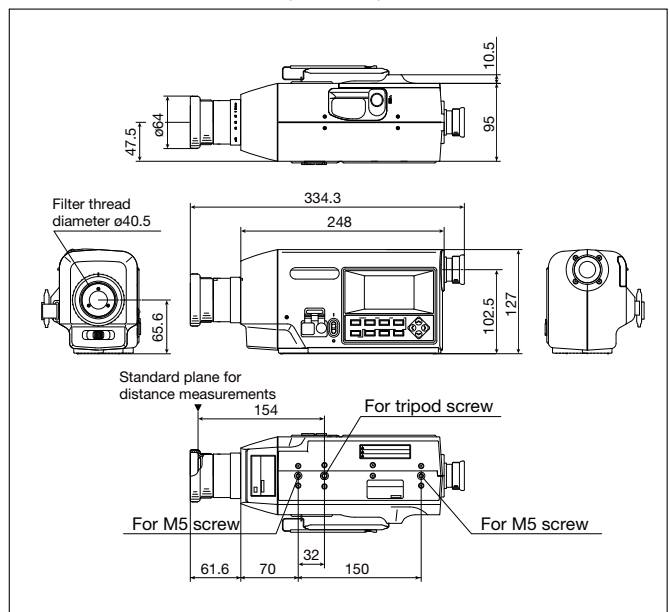

- Specifications are subject to change without notice.

### Customization service:

In order to meet customer needs even more fully, Konica Minolta offers a customization service for modifying products currently being sold.

#### Main customization service for CS-200 :

##### Modification of measuring angle to 2°

Customized products will have specifications (such as accuracy and repeatability) different from those of our normal products. Please ask your nearest Konica Minolta dealer for details.

<http://konicaminolta.com/about/se/contact.html>

9242-4810-10 AGMDPK<sup>®</sup> Printed in Japan