



KONICA MINOLTA

# LIGHT METERS

ILLUMINANCE METER

LUMINANCE METER

UV RADIOMETER

CHROMA METER

T-10/T-10M/T-10Ws/T-10W<sub>L</sub>  
LS-100/LS-110  
UM-10  
CL-200  
CS-100A  
DP-10  
DP-101

The essentials of imaging

# ILLUMINANCE METER T-10 Series

**Accurate and Easy Measurement of Illuminance  
Adapts To Various System Configurations  
Modular Systems That Expand With Your Needs**

## Illuminance Meter T-10 <standard receptor head>

Used for measurement of a wide range of illuminance

( 0.01 to 299,900 lx )  
( 0.001 to 29,990 fcd )

## Illuminance Meter T-10M <mini receptor head>

Used for measurement of illuminance that cannot be performed with the standard receptor head due to small spaces.

The measuring range is the same as T-10 ( 0.01 to 299,900 lx )  
(ø14 mm receptor surface, 1 m cord) ( 0.001 to 29,990 fcd )

## Illuminance Meter T-10Ws (5m cord) / T-10WL (10m cord)

Custom order

Since the mini receptor head and cord are waterproofed to allow measurement of illuminance under water, this product can be used for control of illuminance in the marine products industry (e.g. fish farming) and outdoor measurement of illuminance on rainy days.



T-10



T-10M/T-10Ws/T-10WL

## WIDE RANGE OF APPLICATIONS

- Lighting engineers and specifiers
- R&D at light products manufacturers
- inspection of light sources at construction sites, government and educational facilities
- maintenance of lights in factories, offices, and hospitals
- electrical product manufacturers
- quality control of light sources at home
- agricultural and forestry industries.



Under water measuring example

## Main Features

### Provides multi functions and user-friendly features

For basic operation

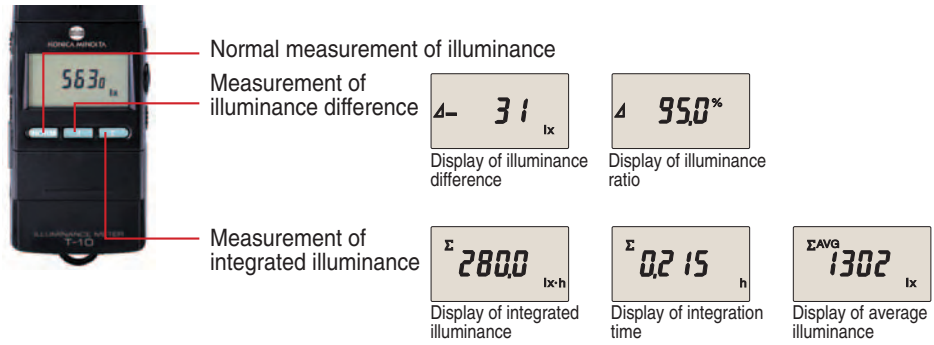

For advanced operation

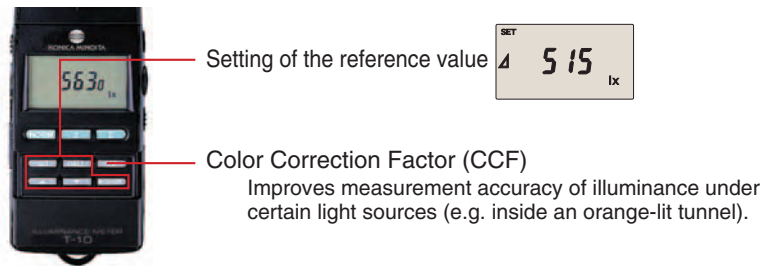

### Allows connection with a personal computer and continuous recording of illuminance by a recorder

Digital output : Use of the RS232C interface (standard accessory) allows the meter to be connected to a personal computer.

Analog output : Allows the meter to be connected to a recorder for continuous recording of illuminance.

### Quick automatic zero adjustment

Turning on the meter will perform zero adjustment (no cap required), allowing immediate measurement of illuminance.

### Auto ranging

Range can also be set manually.

### LCD back-light

The LCD back-light turns on automatically when illuminance is low.

### Uses AA-size batteries.

### Measures flickering light sources

## Illuminance Measurement System to Meet Various Needs

Allows simple and low-cost multi-point measurement of illuminance (2 to 30 points).

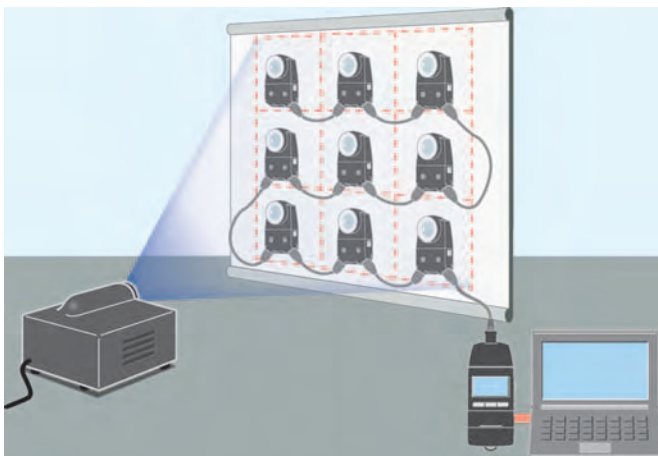

Multi-point illuminance measurement system (9 points)  
For projector etc

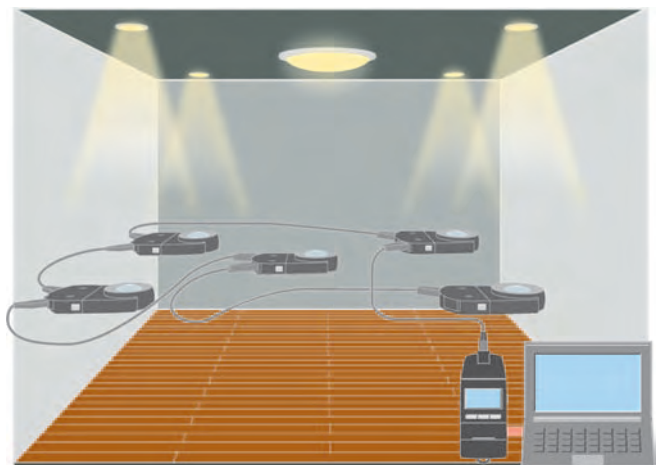

Multi-point illuminance measurement system (5 points)  
For lighting at construction sites



## Relative Spectral Response

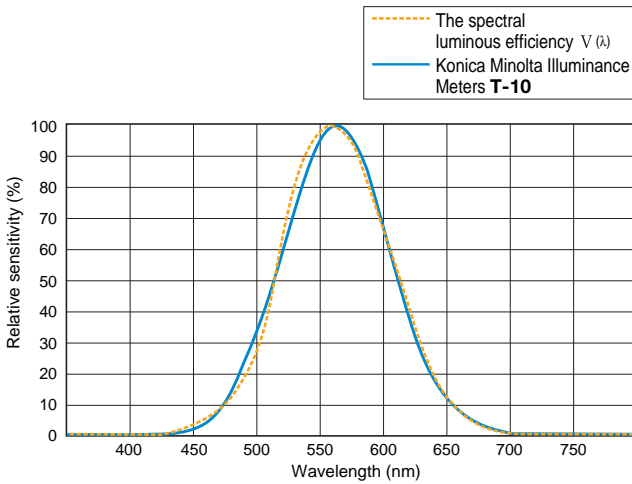

Ideally, the relative spectral responsivity of the illuminance meter should match  $V(\lambda)$  of the human eye for photopic vision. As shown in the graph at left, the relative spectral responsivity of Konica Minolta Illuminance Meters **T-10** is within 8% ( $f1$ ) of the CIE spectral luminous efficiency  $V(\lambda)$ .

CIE ; Commission Internationale de l'Eclairage

$f1$  (CIE's symbol) ; The degree to which the relative spectral responsivity matches  $V(\lambda)$  is characterized by means of the error  $f1$ .

## Cosine Correction Characteristics

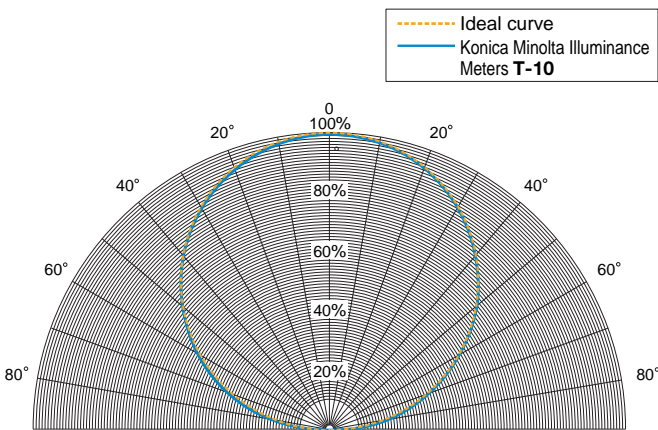

Since the brightness at the measurement plane is proportional to the cosine of the angle at which the light is incident, the response of the receptor must also be proportional to the cosine of the incidence angle.

The graph at left shows the cosine correction characteristics of Konica Minolta Illuminance Meters **T-10**.

The cosine error of **T-10** are shown in the table right.

Incidence angle (deg.)	Cosine error (within)
10°	± 1%
30°	± 2%
50°	± 6%
60°	± 7%
80°	± 25%

## Illuminance measurement

Example of multi-point illuminance measurement (9 points)

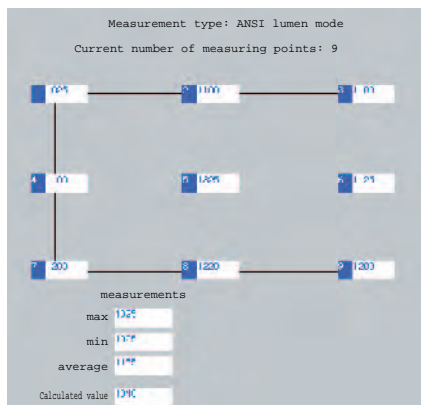

\*\*sensor position

Units No.	Mass (mg)	Area	Sensor 1	Sensor 2	Sensor 3
1	104.00	1150	1025	1130	1160
2	104.00	1115	1020	1130	1089
3	104.00	1122	1010	1130	1081
4	104.00	1180	1020	1130	1100
5	104.00	1151	1023	1130	1083

\*grid

This optional PC software offers several desirable features (e.g. easy operation, visual data display, and flexible data processing).

This software provides multi-point graphical data.

Examples shown: grid\*, trend graph, and sensor position.\*\*

- Single-point measurement and Multi-point measurement (2 to 30 points) are available.
- Automatic measurement at user-selected intervals.
- Tolerance setting.
- Capability of file save, print-out and data-transfer to excel sheet.

OS	Windows®95/98/NT (ver4)
CPU	Pentium 166 MHz or higher
Memory	32MB or more
Hard disk	20MB or more free space
Display resolution	800 x 600 or higher

\*Windows® and \*Excel® are a trademark of Microsoft Corporation in the USA and other countries.

Specifications are subject to change without notice.

# SYSTEM DIAGRAM

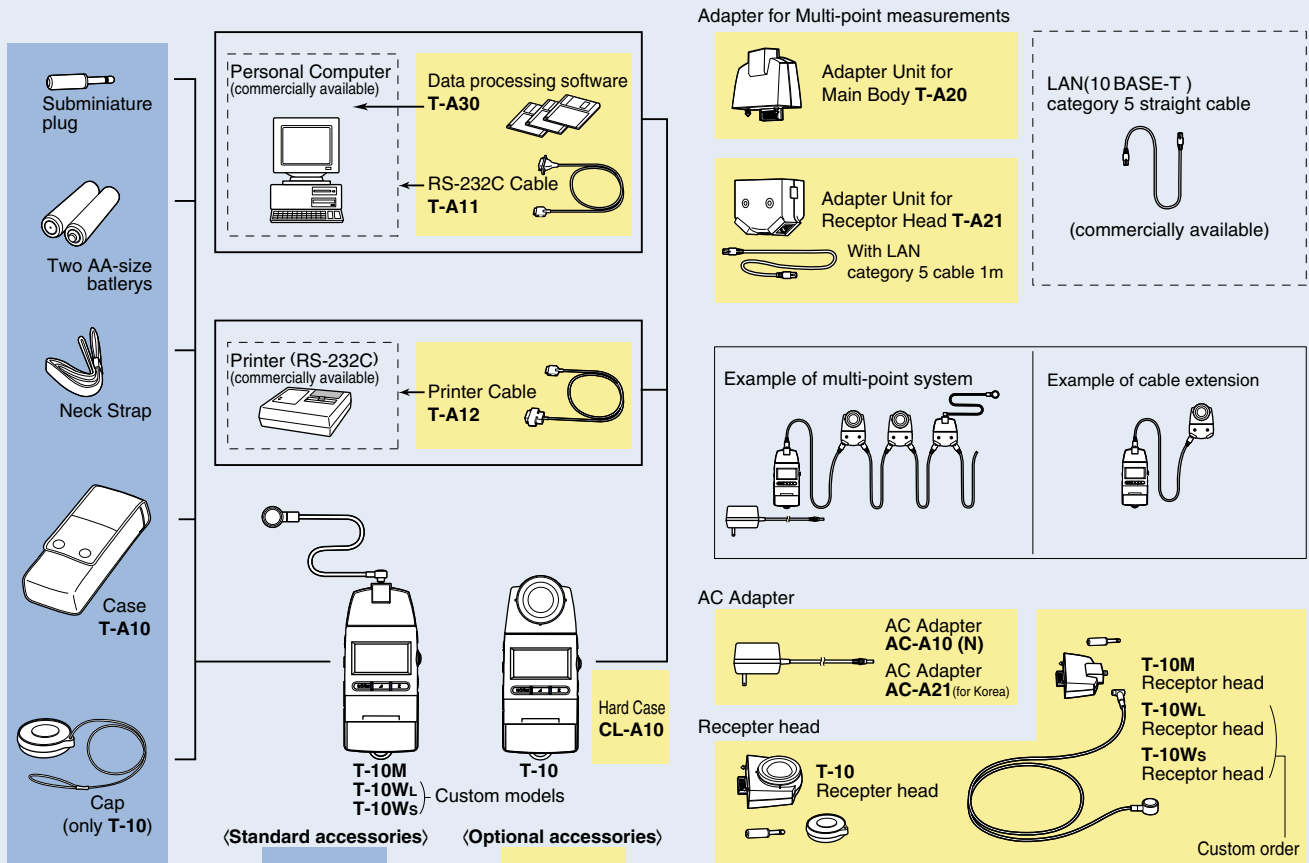

## SPECIFICATIONS

Model	Illuminance meter T-10 <standard receptor head>	Illuminance meter T-10M <mini receptor head>
Type	Multi-function digital illuminance meter with detachable receptor head	
Receptor	Silicon photocell	
Relative Spectral Response*	Within 8% (f1') of the CIE spectral luminous efficiency V (λ)	
Cosine Correction Characteristics	Within ±1% at 10° ; Within ±2% at 30° ; Within ±6% at 50° ; Within ±7% at 60° ; Within ±25% at 80°	
Illuminance units	Lux (lx) or foot candles (fcd) (switchable)	
Measuring range	Auto range (manual 5 range at the time of analog output)	
Measuring function	Illuminance(lx), illuminance difference(lx), illuminance ratio(%), integrated illuminance(lx·h), integration time(h), average illuminance(lx).	
Measuring range	Illuminance..... 0.01 to 299,900 lx 0.001 to 29,990 fcd Integrated illuminance..... 0.01 to 999,900 x 10 <sup>3</sup> lx·h 0.001 to 99,990 x 10 <sup>3</sup> fcd·h / 0.001 to 9999 h	
User calibration function	CCF(Color Correction Factor) setting function	
Accuracy	±2% ±1digit of displayed value (based on Konica Minolta standard)	
Temperature/humidity drift	Within ±3% ±1digit (of value displayed at 20°C/68°F ) within operating temperature/humidity range	
Digital output	RS-232C	
Analog output	1mV/digit, 3V at maximum reading; Output impedance: 10KΩ; 90% response time: FAST setting: 1ms, SLOW setting: 1s	
Display	3 or 4 Significant-digit LCD with back-light illumination	
Operating temperature /humidity range	-10 to 40°C, relative humidity 85% or less (at 35°C) with no condensation	
Storage temperature /humidity range	-20 to 55°C, relative humidity 85% or less (at 35°C) with no condensation	
Power source	2 AA-size batteries / AC adapter (optional)	
Battery life	72 hours or longer (when alkaline batteries are used) in continuous measurement	
Dimensions	69 x 174 x 35 mm (2-6/16x6-14/16x1-7/16 in.)	Main body : 69 x 161.5 x 30 mm (2-6/16x6-6/16x1-3/16 in.) Receptor : ø16.5 x 12.5 (ø11/16 x 1/2 in.) Cord length : 1m (3.3 in.)
Weight	200g (7.0 oz.) without battery	205g (7.2 oz.) without battery
Standard accessories	ø3.5mm(ø1/8 in.) subminiature plug for analog output ; Receptor cap ; Neck strap ; Case ; Battery	ø3.5mm(ø1/8 in.) subminiature plug for analog output ; Neck strap ; Case ; Battery
Optional accessories	Receptor head ; Adapter for Multi-point ; AC Adapter ; Data processing software	

\* Equivalent to 2% specified for T-1 series.  
8% CIE(f1'), new JIS(1993)  
2% old JIS

Specifications are subject to change without notice.

# LUMINANCE METERS LS-100/LS-110

**Compact, lightweight, easy-to-use SLR luminance meters with a wide measuring range**

## Luminance Meter LS-100

1° acceptance angle,  
Measuring range: 0.001 to 299,900cd/m<sup>2</sup>  
(0.001 to 87,530fL)

## Luminance Meter LS-110

1/3° acceptance angle,  
Measuring range: 0.01 to 999,900cd/m<sup>2</sup>  
(0.01 to 291,800fL)



LS-100

### MAIN FEATURES

#### Flareless SLR optical system for accurate measurements

The SLR (single-lens-reflex) optical system allows precise aiming and ensures that the viewfinder shows the exact area to be measured. The optical system is also virtually flareless, eliminating the influence of light from outside the measurement area.

#### Narrow acceptance angle for measurements of small specimens

Acceptance angles of only 1° for **LS-100** and 1/3° for **LS-110** allow accurate measurements of small specimen areas. In addition, optional close-up lenses can be used to measure areas as small as ø1.3mm when using **LS-100** and ø0.4mm when using **LS-110**.

#### User calibration and color-correction functions

To increase the versatility of the **LS-100** and **LS-110**, both models are equipped with user calibration and color correction functions. The user calibration function allows the meter to be calibrated to a user-selected standard instead of the preset Konica Minolta standard; this function can also be used to standardize the response of several meters. The color correction function allows the response of the meter to be adjusted when measuring colored specimens.

#### Luminance ratio and peak luminance measurements

In addition to measurements of the present luminance, the **LS-100** and **LS-110** can also determine the percent ratio of the measured luminance to a luminance value stored in memory as well as the peak luminance or luminance ratio measured.

#### RS-232C data communication

Use of the built-in RS-232C interface allows the meter to be connected to a personal computer.

#### Lightweight, compact design powered by a single 9V battery for portability

(Power can also be supplied by optional Data Printer **DP-10**.)

### RELATIVE SPECTRAL RESPONSE

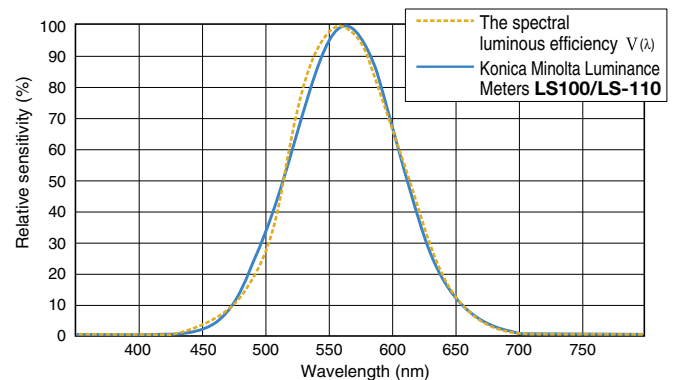

Ideally, the relative spectral responsivity of the luminance meter should match  $V(\lambda)$  of the human eye for photopic vision. As shown in the graph above, the relative spectral responsivity of Konica Minolta Luminance Meters **LS-100/LS-110** is within 8% (f1') of the CIE spectral luminous efficiency  $V(\lambda)$ .

CIE ; Commission Internationale de l'Éclairage  
f1' (CIE-εs symbol) ; The degree to which the relative spectral responsivity matches  $V(\lambda)$  is characterized by means of the error f1'.

### REDUCTION OF FLARE

The degree to which the influence of light from outside the defined measuring area is eliminated is an important factor in the performance of luminance meters. In Konica Minolta Luminance Meters, the flare factor is kept to below 1.5%, even if an object with extremely high luminance is just outside the meter's measuring area.

The graph at right shows the effect when a bright point is moved from A inside the measuring area to B just outside the measuring area.

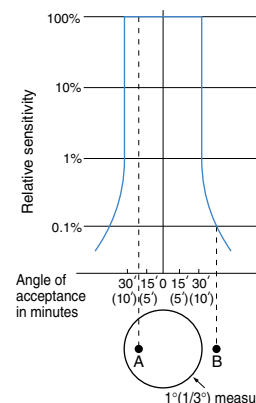

If the measured value at A is defined at 100%, the measured value at B would be less than 0.1%.

## SPECIFICATIONS

Model	Luminance Meter <b>LS-100</b>		Luminance Meter <b>LS-110</b>
Type	SLR spot luminance meter for measuring light-source and surface brightness		
Measuring angle	1°		1/3°
Optical system	85mm f/2.8 lens; SLR viewing system; flare factor less than 1.5%		
Angle of view	9°		
Focusing distance	1014mm (40 in.) to infinity		
Minimum measuring area	ø14.4mm		ø4.8mm
Receptor	Silicon photocell		
Relative Spectral Response*	Within 8% (f1') of the CIE spectral luminous efficiency V (λ)		
Response time	FAST: Sampling time: 0.1s, time to display: 0.8 to 1.0s; SLOW: Sampling time: 0.4s, time to display: 1.4 to 1.6s		
Luminance units	cd/m <sup>2</sup> or fL (switchable)		
Measuring range	FAST: 0.001 to 299,900cd/m <sup>2</sup> (0.001 to 87,530fL) SLOW: 0.001 to 49,990cd/m <sup>2</sup> (0.001 to 14,590fL)		FAST: 0.01 to 999,900cd/m <sup>2</sup> (0.01 to 291,800fL) SLOW: 0.01 to 499,900cd/m <sup>2</sup> (0.01 to 145,900fL)
Accuracy	0.001 to 0.999cd/m <sup>2</sup> (or fL): ±2% ±2 digits of displayed value 1.000cd/m <sup>2</sup> (or fL) or greater: ±2% ±1 digit of displayed value (Illuminant A measured at ambient temperature of 20 to 30°C/68 to 86°F)		0.01 to 9.99cd/m <sup>2</sup> (or fL): ±2% ±2 digits of displayed value 10.00cd/m <sup>2</sup> (or fL) or greater: ±2% ±1 digit of displayed value
Repeatability	0.001 to 0.999cd/m <sup>2</sup> (or fL): ±0.2% ±2 digits of displayed value 1.000cd/m <sup>2</sup> (or fL) or greater: ±0.2% ±1 digit of displayed value (Measurement subject: Illuminant A)		0.01 to 9.99cd/m <sup>2</sup> (or fL): ±0.2% ±2 digits of displayed value 10.00cd/m <sup>2</sup> (or fL) or greater: ±0.2% ±1 digit of displayed value
Temperature/humidity drift	Within ±3% ±1 digit (of value displayed at 20°C/68°F) within operating temperature /humidity range		
Calibration mode	Minolta standard/user-selected standard (switchable)		
Color correction factor	Set by numerical input; range: 0.001 to 9.999		
Reference luminance	1; set by measurement or numerical input		
Measurement modes	Luminance; luminance ratio; peak luminance or luminance ratio		
Display	External: 4-digit LCD with additional indications Viewfinder: 4-digit LCD with LED backlight		
Data communication	RS-232C; baud rate: 4800bps		
External control	Measurement process can be started by external device connected to data output terminal		
Power source	One 9V battery; power can also be supplied by optional Data Printer DP-10		
Power consumption	While measuring button is pressed and viewfinder display is lit: 16mA average While power is on and viewfinder display is not lit: 6mA average		
Operating temperature/humidity range	0 to 40°C, relative humidity 85% or less (at 35°C) with no condensation		
Storage temperature /humidity range	-20 to 55°C, relative humidity 85% or less (at 35°C) with no condensation		
Dimensions	79x208x150mm (3-1/8x8-3/16x5-7/8 in.)		
Weight	850g (30 oz.) without battery		
Standard accessories	Lens cap; Eyepiece cap; ND eyepiece filter; 9V battery; Case		

\* Equivalent to 2% specified for T-1 series.  
8% CIE(f1'), new JIS(1993)  
2% old JIS

Specifications are subject to change without notice.

## OPTIONAL ACCESSORIES

### Data Printer DP-10

A compact, lightweight data printer with built-in D/A converter

Compact, lightweight, and battery-powered for complete portability

#### Timer-controlled measurements

Measurements can be taken automatically at intervals of 10s, 30s, 2m, or 10m.

Optional AC Adapter can be used. Power can also be supplied to the Luminance Meter from the DP-10.

#### Built-in D/A converter

Analog output is provided for connection to an analog recorder or similar device when taking continuous measurements.

Six analog output ranges: 10, 10<sup>2</sup>, 10<sup>3</sup>, 10<sup>4</sup>, 10<sup>5</sup>, or 10<sup>6</sup> (cd/m<sup>2</sup> or fL)

## SPECIFICATIONS (DP-10)

Type	24-character thermal-dot (7x5 dot matrix)	
Printing speed	0.8s/line (1.2s/line including return to start of next line)	
Printed data	Measurement number: 1 to 9,999 Measured values: Maximum 6 digits Elapsed time since first measurement: 00:00 to 99:59 (h:m)	
Interval timer	Interval time: 10s, 30s, 2m, or 10m Automatic printout after measurement	
Analog output	Output range	10, 10 <sup>2</sup> , 10 <sup>3</sup> , 10 <sup>4</sup> , 10 <sup>5</sup> , or 10 <sup>6</sup> (cd/m <sup>2</sup> or fL); manually selected
	Output voltage	1V (full scale)
	Output resolution	0.1mV/digit (1mV/digit when range of 10 is selected when using LS-110)
	Response time	300ms
	Temperature drift	0.02mV/°C
Accuracy	0.4% of value displayed by Luminance Meter ±0.2mV	
Power source	6 AA-size batteries or optional AC Adapter (output: 9V, 1A)	
Dimensions	186x53x102mm (7-5/16x2-1/16x4 in.)	
Weight	440g (15.5 oz.) without batteries or thermal paper	

Specifications are subject to change without notice.

### Close-Up Lenses



Minimum measuring area		
Close-Up Lenses	With LS-100	With LS-110
No. 153	ø8.0mm	ø2.7mm
No. 135	ø5.2mm	ø1.8mm
No. 122	ø3.2mm	ø1.1mm
No. 110	ø1.3mm	ø0.4mm

### Long Eye-Relief Eyepiece



When the Long Eye-Relief Eyepiece is used, the measuring area and measurement display inside the viewfinder can be seen with the eye 5cm (2 in.) away from the eyepiece.

### Angle Finder Vn



Angle Finder Vn allows the measuring area and measurement display inside the viewfinder to be seen at an angle of 90° to the normal viewfinder optical axis. Angle Finder Vn can also be focused and the magnification can be set to 1x or 2x.

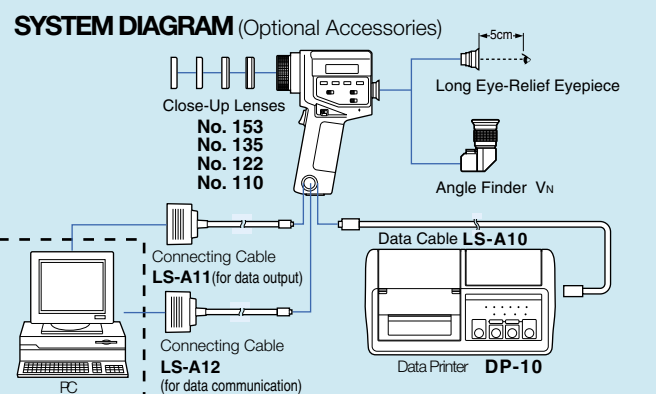



# UV RADIOMETER UM-10

**An easy-to-use instrument for measuring ultraviolet radiation. Choose from three different high-sensitivity receptor heads according to your application.**



## MAIN FEATURES

**Easy operation**

**Wide total measuring range (0.1 to 199,900 $\mu$ W/cm<sup>2</sup>) with automatic range selection**

**Choice of three different receptor heads to match specific applications**

**Compact, handheld design**

**Digital (RS-232C) and analog output terminals**

## MAIN APPLICATIONS

### Fields Utilizing Photochemical Reactions

- Checking exposure of photoresists in semiconductor manufacturing
- Checking exposure of emulsions for printing or platemaking
- Testing fading due to UV exposure
- Evaluating characteristics of solar cells
- Testing deterioration of products due to UV exposure

### Fields Utilizing Biological Applications of UV Exposure

- Diagnosis of erythema and other skin pigmentation problems
- Treatment of white skin spots or oversensitivity to light
- Optimization and control of breeding conditions for fish and domestic animals
- Suppressing growth of useless shoots on plants
- Monitoring conditions for photosynthesis

### Fields Utilizing the Photoelectric Effect

- Electrophotography
- Electrographic etching

### Fields Requiring Use of Sterilization Lamps

- Food processing
- Beauty treatment
- Scientific research

**Other fields which require adjustment, monitoring, or research of ultraviolet light and light sources**

## THREE DIFFERENT RECEPTOR HEADS

**Receptor Head UM-250 (220 to 300nm)**      **Receptor Head UM-360 (310 to 400nm)**      **Receptor Head UM-400 (360 to 480nm)**

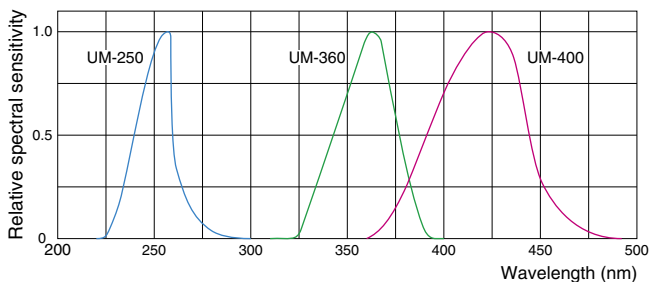

## EXAMPLES OF SUBJECT LIGHT SOURCES

- Fluorescent health lamps
- High-pressure mercury lamps
- Ultra-high-pressure mercury lamps
- Photopolymerization lamps
- Blacklight lamps
- Copier lamps
- Xenon lamps
- Fluorescent lamps
- Sterilization lamps



## EXAMPLES OF SUBJECT LIGHT SOURCES

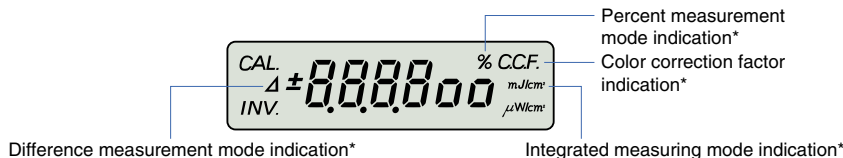

\* Available only when optional Expansion Keyboard **UM-A25** is attached.

## OPTIONAL ACCESSORIES



### Expansion Keyboard UM-A25

With Expansion Keyboard **UM-A25** attached, the following functions are added.

#### Integrated irradiance

The total irradiance received over a period of time can be measured.  
 Maximum integrated irradiance  
 Approx. 1,000,000,000mJ/cm  
 Maximum integration time: 999.900sec

#### Color correction factor

By setting the appropriate color correction factor, the **UM-10** can be adjusted to more accurately measure the irradiance of different lamp types.

#### Irradiance difference

The difference between a measured irradiance and a target irradiance\* stored in memory can be determined.

#### Percent irradiance

The measured irradiance as a percentage of a target irradiance\* stored in memory can be determined.

\*The target irradiance can be measured or input as numerical values.

### SYSTEM DIAGRAM

(Optional Accessories)

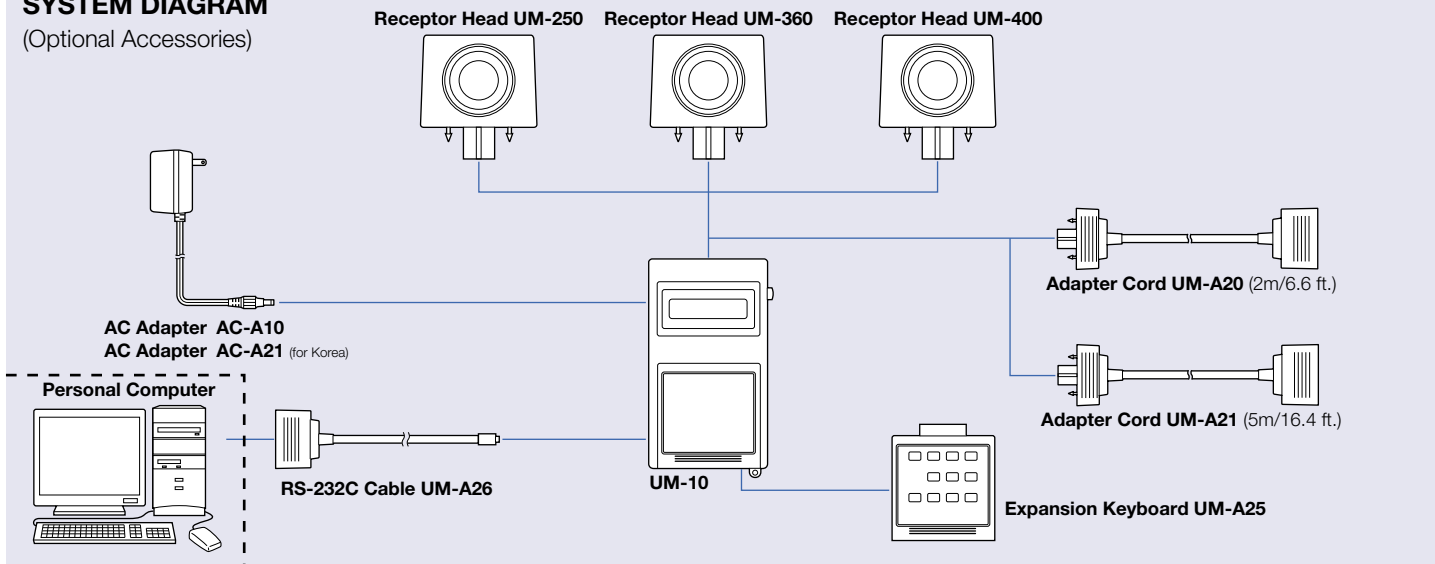

### SPECIFICATIONS

Type	Irradiance meter with interchangeable receptor heads for measuring UV radiation		
Receptor heads	Receptor	Silicon photodiode	
	Model	<b>UM-250</b>	<b>UM-360</b>
	Spectral response	220 to 300nm	310 to 400nm
	Peak wavelength	250±10nm	365±5nm
Cosine error	30°	Within ±3%	Within ±3%
	60°	Within ±15%	Within ±10%
Measurement modes	Irradiance ;integrated irradiance*and integration time*;irradiance difference*;percent irradiance*		
Irradiance measuring range	0.1 to 199,900μW/cm <sup>2</sup> in four automatically selected ranges		
Integrated irradiance range*	Maximum approx.100000mJ/cm <sup>2</sup> measurable (in 9999 display cycles)		
Integration time*	999,900sec.(288h)		
Linearity	Within ±5% of reading = 1 digit		
Temperature/humidity drift	Within ±3% ±1 digit (of value displayed at 23°C/73.4°F) within operating temperature/humidity range		
Analog output	0 to 3V;1mV/digit		
Digital output	RS-232C 2400BPS		
Display	4-digit LCD		
Operating temperature/humidity range	0 to 40°C, relative humidity 85% or less (at 35°C) with no condensation		
Storage temperature/humidity range	-20 to 55°C, relative humidity 85% or less (at 35°C) with no condensation		
Power source	One 9V battery or optional AC adapter		
Dimensions	73.5X186X33mm(2-7.8X7-5/16X1-5/16 in)		
Weight	270g(9.5 oz.) including battery		
Standard accessories	Case;Cap;Strap;Analog output plug		

\*Available only with optional Expansion Keyboard **UM-A25** attached.  
 Specifications are subject to change without notice.

# CHROMA METER CL-200

**Enables measurement of tristimulus values, chromaticity, color difference, correlated color temperature and illuminance of light sources.**



## MAIN FEATURES

### Four types of calibration functions for correcting measurement values:

Normal Calibration : Corrects measurement values for Standard Illuminant A as the calibration light source

Normal User Calibration : Corrects measurement values for input calibration light source values

Multi Calibration : Corrects measurement values for the R/G/B/W values of ultra-high-pressure mercury lamps

Multi User Calibration : Corrects measurement values for input calibration light source values for R/G/B/W

- Input of R/G/B/W values for Multi User Calibration requires Data Processing Software CL-S1w,(sold separately)

### Enables multi-point measurement

Allows simple and low-cost multi-point measurement. Up to 30 receptors can be connected to one main body.

### Simple operation

- Turning on the meter will perform zero adjustment (no cap required), allowing immediate measurement.
- Keys that are not used frequently can be placed under a sliding cover, to prevent pressing a key in error and to give the operating panel a neat appearance.

### Other features

- The receptor can be separated and then connected to the main body with a LAN cable. This allows the user to install the receptor up to 100m from the main body and control it remotely. (For this, optional adapters T-A20 (for main body) and T-A21 (for receptor) are required.)
- Use of the built-in RS232C interface allows the meter to be connected to a personal computer. (For RS-232C interface, an optional cable (T-A11) is available.)
- Connecting to a commercially available thermal printer allows printout of measured data. (For connecting to a printer, an optional printer cable (T-A12) is available.)
- The LCD back-light turns on automatically when illuminance is low.
- Powered by AA-size batteries or optional AC adapter.
- This optional PC software offers several desirable features (e.g. easy operation, visual data display, and flexible data processing). This software provides multi-point graphical data.

## MAIN APPLICATIONS

- R&D and color inspection of light sources in a variety of industries, eg, lamp manufacturers, building and interior design.
- Setting up projectors for presentation purposes.
- Color adjustment of CRTs, flat panel and other display devices.
- Color evaluation and control of light boxes and light booths.
- Evaluating color in an experimental environment for psychology.

## SPECIFICATIONS

Relative Spectral Response*	Closely matches CIE Standard Observer curves $\bar{x}(\lambda)$ , $\bar{y}(\lambda)$ , and $\bar{z}(\lambda)$ Within 8% (f1') of the CIE spectral luminous efficiency $V(\lambda)$
Receptor	Silicon photocell
Measuring function	Tristimulus values : XYZ Chromaticity : Ev xy, Ev u'v' Correlated color temperature : Ev, Tcp, Δuv Color difference : Δ(XYZ), Δ(Ev xy), Δ(Ev u'v'), ΔEv Δu'v'
Other function	User calibration function, Data hold function, Multi-point measurement (2 to 30 points)
Measuring range	0.1~99,990 lx, 0.01~9,999 fcd (Chromaticity : 5 lx, 0.5 fcd or above) in four automatically selected ranges (lx or fcd is switchable)
Accuracy	Ev : ±2% ±1digit of displayed value (based on Minolta Standard) xy : ±0.002 (800 lx, standard illuminant A measured)
Repeatability	Ev : 0.5% +1digit (2σ) (800 lx, standard illuminant A measured) xy : ±0.0005
Temperature drift	Ev : ±3% ±1digit of displayed value, xy : ±0.003
Humidity drift	Ev : ±3% ±1digit of displayed value, xy : ±0.003
Response time	0.5 sec. (continuous measurement)
Digital output	RS-232C
Display	4 Significant-digit LCD with back-light illumination
Operating temperature /humidity range	-10 to 40°C, relative humidity 85% or less (at 35°C) with no condensation
Storage temperature /humidity range	-20 to 55°C, relative humidity 85% or less (at 35°C) with no condensation
Power source	2 AA-size batteries / AC adapter (optional)
Battery life	72 hours or longer (When alkaline batteries are used) in continuous measurement
Dimensions	69x174x35mm (2-6/16x6-14/16x1-7/13 in.)
Weight	215g (7.6 oz.) not including batteries

Specifications are subject to change without notice.

\* Equivalent to 2% specified for T-1 series. 8% CIE(f1'), new JIS(1993) 2% old JIS

## DIMENSIONS

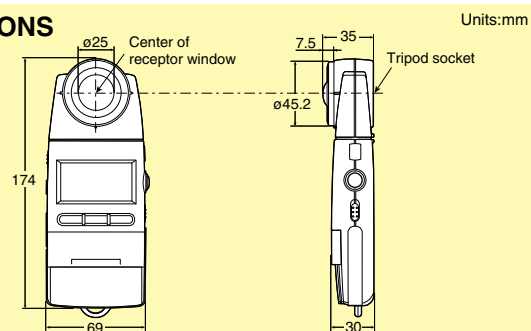

### Allows simple and low-cost multi-point measurement (2 to 30 points).

Up to 30 receptors can be connected to one main body. (For multi-point measurement, optional adapters T-A20 (for main body) and T-A21 (for receptor) are required.)

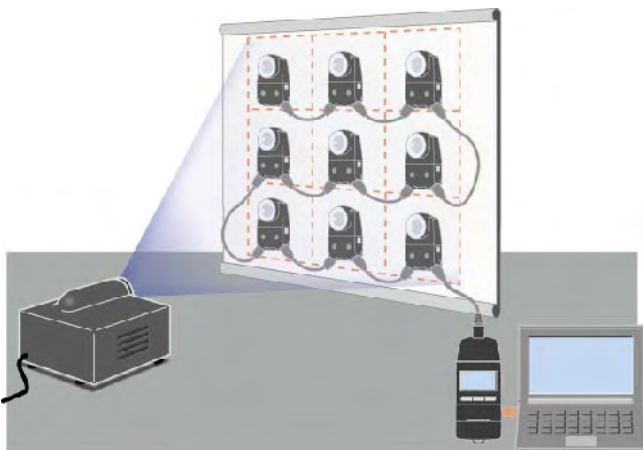

### Dedicated PC software

This optional PC software offers several desirable features (e.g. easy operation, visual data display, and flexible data processing). This software provides multi-point graphical data.

- Single-point measurement and Multi-point measurement (2 to 30 points) are available.
- Automatic measurement at user-selected intervals.
- Tolerance setting.
- Capability of file save and print-out.

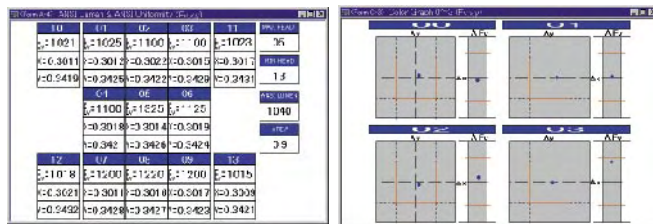

OS Windows® 95/98/NT (ver4)  
 CPU Pentium 300 MHz or higher  
 Memory 32MB or more  
 Display resolution 800 x 600 or higher

\* Windows® is a trademark of Microsoft Corporation in the USA and other countries.

### SYSTEM DIAGRAM

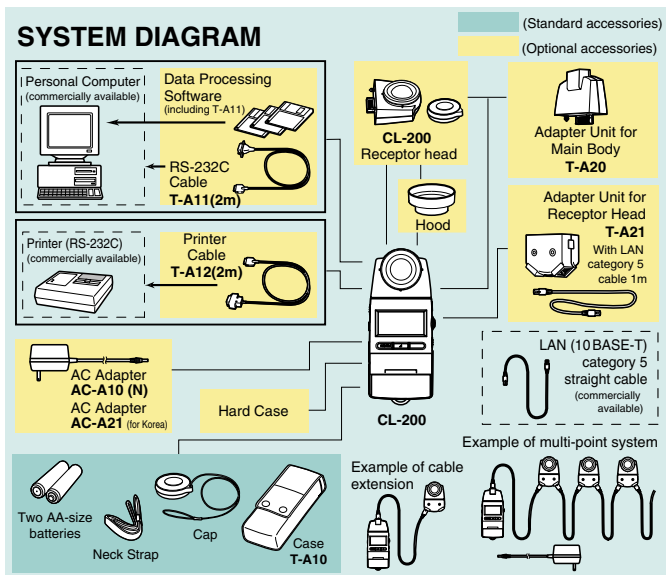

### < Illuminance Measurement Performance >

#### – Relative Spectral Response –

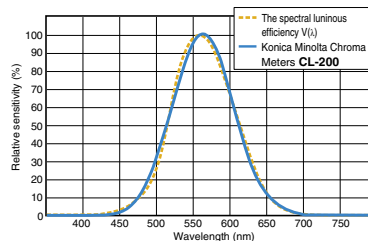

Ideally, the relative spectral responsivity of the illuminance meter should match  $V(\lambda)$  of the human eye for photopic vision. As shown in the graph above, the relative spectral responsivity of Konica Minolta Chroma Meters CL-200 is within 8% ( $f_1'$ ) of the CIE spectral luminous efficiency  $V(\lambda)$ .

CIE: Commission Internationale de l'Eclairage  
 $f_1'$ (CIE's symbol); The degree to which the relative spectral responsivity matches  $V(\lambda)$  is characterized by means of the error  $f_1'$ .

#### – Cosine Correction Characteristics –

Since the light at the measurement plane is proportional to the cosine of the angle at which the light is incident, the response of the receptor must also be proportional to the cosine of the incidence angle.

The graph above shows the cosine correction characteristics of Konica Minolta Chroma Meters CL-200. The cosine error of CL-200 is shown in the table right.

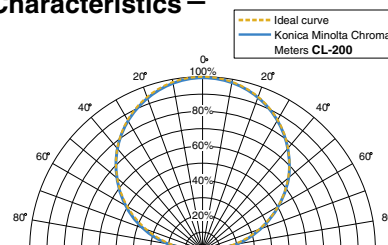

### < Chromaticity and Color Temperature >

#### – Chromaticity (xy) –

XYZ tristimulus values and the associated Yxy color space form the foundation of the present system for numerical color notation. The concept for the XYZ tristimulus values is based on the premise that all colors are seen as mixtures of these three primary colors. By defining the color matching functions of a Standard Observer, the Commission Internationale de l'Eclairage (CIE), an international organization concerned with light and color, provided the basis for colorimetry in 1931.

The tristimulus values XYZ are useful for specifying a color, but the results are not easily visualized.

The two-dimensional color (x,y) diagram is taken from the Yxy color space, in which Y is the lightness (and is identical to the tristimulus value Y) and x and y are the chromaticity coordinates calculated from the tristimulus values XYZ. The CIE x, y chromaticity diagram for this color space is shown. In this diagram, achromatic colors are toward the center of the diagram, and the chroma or saturation increases toward the edges.

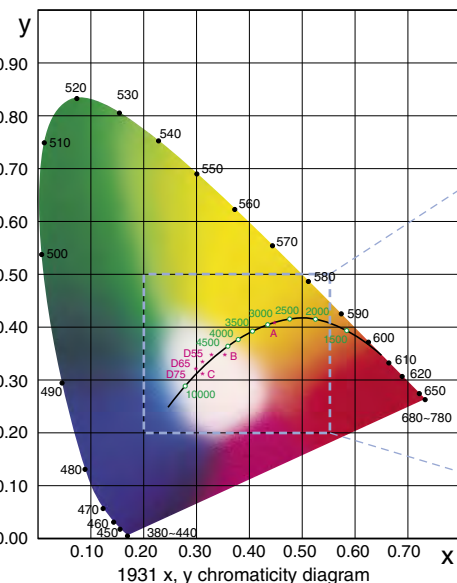

#### – Color Temperature (T<sub>cp</sub>) –

A black body (perfect radiant body) is an ideal object that absorbs all energy, changes its color from red through yellow to white as its temperature increases. The absolute temperature T (K) of the black body is referred to as the color temperature. The xy chromaticity diagram given on the left shows the relationship between the temperature and color by a locus (black body locus).

The diagram given below is sometimes used to indicate the color of a light source. Correlated color temperature is used to apply the general idea of color temperature to those colors that are close to, but not exactly on the blackbody locus. For instance, a light source which has a color difference of 0.01 in the green direction ( $\Delta uv$ ) from a black body which has a color temperature of 7,000K is indicated as having a correlated color temperature of 7,000K + 0.01 (uv unit).

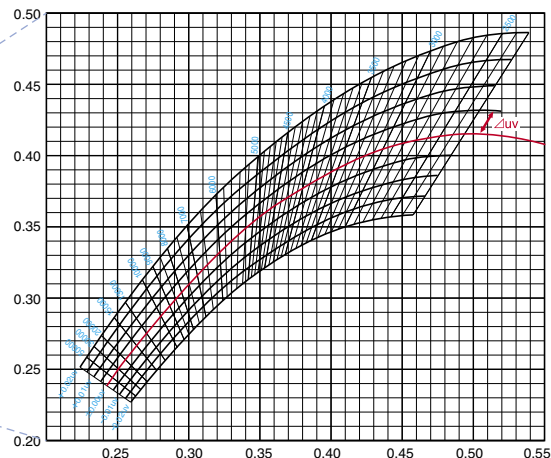

xy chromaticity chart indicating the black body locus, the isotherm lines and equal  $\Delta uv$  lines.

# CHROMA METER CS-100A

**A compact, lightweight, battery-powered instrument with a 1° measurement angle for high-accuracy non-contact measurements of the luminance and chromaticity of light sources and reflective subjects**



## EASY-TO-READ DISPLAY

### Viewfinder Image

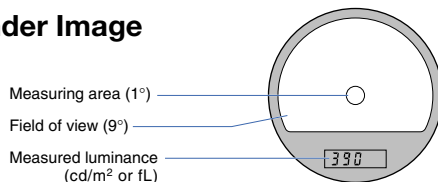

### External display

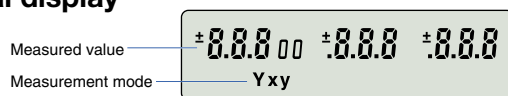

## MAIN FEATURES

### Compact and lightweight

### Measurements of subjects at a distance

SLR (single-lens-reflex) viewing system and flare-free optical system provide accurate measurements of subjects at a distance with virtually no influence from light outside the measurement area

### Measurements of small subjects

1° measurement angle allows measurements of subjects as small as  $\phi 14.4\text{mm}$  (at a subject distance of 1014mm); by using optional Close-Up Lenses, subjects as small as  $\phi 1.3\text{mm}$  can be measured.

### Color difference can also be measured

### Calibration to a user-selected reference is also possible

### Luminance units of $\text{cd}/\text{m}^2$ or $\text{fL}$ can be selected

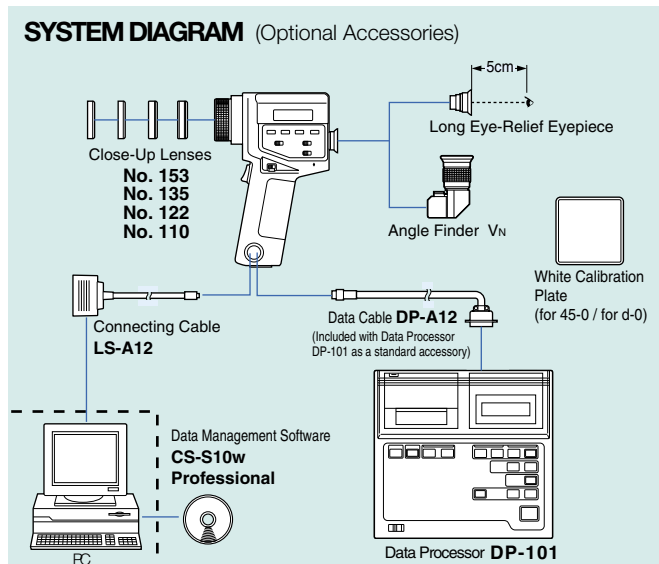

## MAIN APPLICATIONS

### Light-Source Measurements

- Luminance and chromaticity of small light sources such as LEDs, miniature neon lamps, etc.
- Luminance and chromaticity of general light sources such as tungsten lamps, fluorescent lamps, etc.
- Luminance and chromaticity of traffic signals, airport guidance lights, emergency exit signs, etc.

### Reflective-Subject Measurements

- Color measurements of subjects which cannot be measured by contact methods, such as distant building walls, just-painted surfaces, subjects with complicated shapes, or subjects which should not be touched for sanitary reasons.

### Display Measurements

- Luminance and chromaticity of color TVs and CRTs
- Luminance measurements of monochrome TVs and SRTs
- Luminance and chromaticity of projection TVs and video projectors.

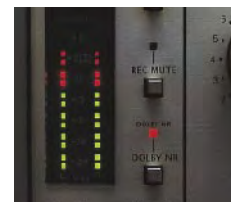

## DIMENSIONS

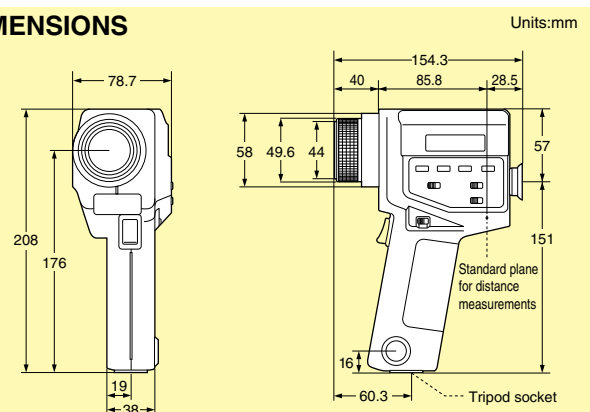



## SPECIFICATIONS

Model	Chroma Meter <b>CS-100A</b>
Type	SLR spot colorimeter for measuring light-source and surface luminance and chromaticity
Measuring angle	1°
Optical system	85mm f/2.8 lens; SLR viewing system; flare factor less than 1.5%
Angle of view	9° with 1° measurement area indication
Focusing distance	1014mm (40 in.) to infinity
Receptors	3 silicon photocells filtered to detect primary stimulus values for red, green and blue light
Spectral response	Closely matches CIE 1931 Standard Observer curves ( $\bar{x}(\lambda)$ , $\bar{y}(\lambda)$ , and $\bar{z}(\lambda)$ )
Response time	FAST: Sampling time: 0.1s, Time to display: 0.8 to 1.0s; SLOW: Sampling time: 0.4s, Time to display: 1.4 to 1.6s
Luminance units	cd/m <sup>2</sup> or fL (switchable)
Measuring range	FAST: 0.01 to 299,000cd/m <sup>2</sup> (0.01 to 87,530fL); SLOW: 0.01 to 49,900cd/m <sup>2</sup> (0.01 to 14,500fL)
Accuracy	Luminance (Y): $\pm 2\%$ of reading $\pm 1$ digit Chromaticity (x,y): $\pm 0.004$ (Illuminant A measured at ambient temperature of 18 to 28°C/64 to 82°F)
Repeatability	Luminance (Y): $\pm 0.2\%$ of reading $\pm 1$ digit Chromaticity (x,y) : FAST: Y 100cd/m <sup>2</sup> or above: $\pm 0.001$ ; 48.1 to 99.9cd/m <sup>2</sup> : $\pm 0.002$ ; below 48.1cd/m <sup>2</sup> : below measurement range SLOW: Y 25.0cd/m <sup>2</sup> or above: $\pm 0.001$ ; 12.0 to 24.9cd/m <sup>2</sup> : $\pm 0.002$ ; below 12.0cd/m <sup>2</sup> : below measurement range (Measurement subject: Illuminant A)
Target value	1; set by measurement or numerical input
Measurement modes	Absolute color: Yxy; color difference: $\Delta(Yxy)$
Display	External: LCD; 3 values (Y, x, and y) of 3 digits each with additional indications Viewfinder: 3-digit LCD (showing luminance value Y) with LED backlight
Data communication	RS-232C; baud rate: 4800bps
External control	Measurement process can be started by external device connected to data output terminal
Power source	One 9V battery; power can also be supplied via data output terminal
Operating temperature /humidity range	0 to 40°C, relative humidity 85% or less (at 35°C) with no condensation
Storage temperature/humidity range	-20 to 55°C, relative humidity 85% or less (at 35°C) with no condensation
Dimensions	79x208x154mm (3-1/8x8-3/16x6-1/16 in.)
Weight	890g (2 lb.) without battery
Standard accessories	Lens cap; Eyepiece cap; Protective filter, ND eyepiece filter; 9V battery; Chromaticity chart; Case

Specifications are subject to change without notice.

## OPTIONAL ACCESSORIES

### Data Processor DP-101

Compact, portable, multi-function data processor to increase the versatility of Minolta Chroma Meter CS-100A

#### Additional Color Notations

When DP-101 is used with the CS-100A, measured values can be calculated in terms of Yxy, L\*a\*b\*, Yu'v', color temperature, and distance from blackbody locus  $\Delta uv$  for absolute color values and in terms of  $\Delta(Yxy)$ ,  $\Delta(L^*a^*b^*)$ ,  $\Delta E^*ab$ ,  $\Delta(Yu'v')$ , and  $\Delta u'v'$  for color difference.



#### Data Storage and Printout

DP-101 has memory space for up to 300 sets of measurement data and a built-in thermal printer for printing out data either at the time of measurement or from memory at a later time.

#### Interval Timer for Automatic Measurements

## SPECIFICATIONS

Type	Battery-powered multi-function data processor for use with Konica Minolta Chroma Meter CS-100A
Measurement modes	Absolute and difference
Chromatic systems	Absolute color: Yxy, Yu'v', L*a*b*, color temperature, distance from blackbody locus $\Delta uv$ Color difference: $\Delta(Yxy)$ , $\Delta(Yu'v')$ , $\Delta u'v'$ , $\Delta(L^*a^*b^*)$ , $\Delta E^*ab$
Calibration channels	4
Target color channels	17 (4 for each calibration channel and 1 quick-input temporary target-color channel); set by measurement or numerical input
Data memory	Space for 300 sets of measurement data divisible into 16 pages; built-in NiCd battery for backup maintains data in memory even if POWER switch is set to OFF
Display	16-character x 2-line dot-matrix LCD with adjustable viewing angle
Printer	24-character thermal-dot
Statistical calculations	Maximum, minimum, mean, and standard deviation
Interval timer	Timer interval user-selectable from 3s to 99m
Data communication	RS-232C format; transmission rate: 9600 baud (can be set by service personnel to 600, 1200, 2400, or 4800; output voltage: CMOS $\pm 5V$ ; RS-232C terminal uses DIN 8-pin connector)
Other	Multiple-measurement-averaging mode; remote-control socket; can supply to CS-100A
Power source	6 AA-size batteries or included AC Adapter
Dimensions	220x50x200mm (8-11/16x2x7-7/8 in.)
Weight	1300g (2.87 lb.) not including batteries
Standard accessories	Data Cable DP-A12; AC Adapter AC-A10; AC Adapter AC-A21 (for Korea); thermal paper (one roll); DIN 8-pin plug (1); 3.5mm (1/8-inch) subminiature plug; Shoulder Case DP-A30

Specifications are subject to change without notice.

### Close-Up Lenses



Close-Up Lenses	Minimum measuring area
No. 153	$\phi 8.0\text{mm}$
No. 135	$\phi 5.2\text{mm}$
No. 122	$\phi 3.2\text{mm}$
No. 110	$\phi 1.3\text{mm}$

### Long Eye-Relief Eyepiece



When the Long Eye-Relief Eyepiece is used, the measuring area and measurement display inside the viewfinder can be seen with the eye 5cm (2 in.) away from the eyepiece.

### Angle Finder Vn



Angle Finder Vn allows the measuring area and measurement display inside the viewfinder to be seen at an angle of 90° to the normal viewfinder optical axis. Angle Finder Vn can also be focused and the magnification can be set to 1x or 2x.

## Data Management Software CS-S10w Professional (Optional accessory)

- Color space** :  $L_v$  x y,  $L_v$  u' v',  $L_v T \Delta uv$ , XYZ, dominant wavelength
- Mode selection** : Normal mode, Object color mode, Contrast mode  
RGB mode, RGB & contrast mode
- Instrument control** : Average measurement, Interval measurement
- Data management** : Reading and saving files, Data management with folders  
Creating, saving and loading templates (customizable design/layouts for various graphs)  
Various graph displays
- Data evaluation** : Observer/Illuminant settings  
Statistics display for each folder  
Box tolerance setting, Multiple-point measurement, uniformity display, contrast display and polygon tolerance setting for display evaluation
- Other** : Creating reports in customizable screen layouts

#### System requirements

<b>OS</b>	Windows®2000 Professional SP4, Windows®XP Professional SP2, Windows®XP Professional x64 Edition
<b>CPU</b>	Pentium®III 600 MHz equivalent or higher (recommended)
<b>Memory</b>	128 MB min. (256 MB or more recommended)
<b>Hard disk</b>	60 MB or more space required for installation
<b>Display</b>	1024 X 768, 256 colors or more
<b>Other</b>	CD-ROM drive, USB port

• Windows® are trademarks of Microsoft Corporation in the USA and other countries.  
• Pentium® is a trademarks of Intel Corporation in the USA and other countries.



KONICA MINOLTA

**SAFETY PRECAUTIONS**

For correct use and for your safety, be sure to read the instruction manual before using the instrument.



- Always connect the instrument to the specified power supply voltage. Improper connection may cause a fire or electric shock.
- Be sure to use the specified batteries. Using improper batteries may cause a fire or electric shock.



Certificate No : YKA 0937154  
Registration Date : March 3, 1995



Certificate No : JQA-E-80027  
Registration Date : March 12, 1997

**KONICA MINOLTA SENSING, INC.**  
**Konica Minolta Sensing Americas, Inc**  
**Konica Minolta Sensing Europe B.V.**

Osaka, Japan  
New Jersey, U.S.A.  
European Headquarter /BENELUX  
German Office (International)  
German Office (Germany)  
French Office  
UK Office  
Italian Office  
Swiss Office  
Nordic Office  
Austrian Office  
Polish Office

**Phone : 888-473-2656(in USA), 201-236-4300(outside USA)**  
Nieuwegein, Netherland  
Langenhagen, Germany  
München, Germany  
Roissy CDG, France  
Milton Keynes, United Kingdom  
Milan, Italy  
Dietikon, Switzerland  
Västra Frölunda, Sweden  
Wien, Austria  
Warszawa, Poland

**Fax : 201-785-2480**  
**Fax : +31(0)30 248-1211**  
**Fax : +49(0)511 7404-807**  
**Fax : +49(0)89 630267-67**  
**Fax : +33(0)1 493-84771**  
**Fax : +44(0)1908 540-629**  
**Fax : +39(0)23 9011219**  
**Fax : +41(0)43 322-9809**  
**Fax : +46(0)31 474945**  
**Fax : +43(0)1 87882-431**  
**Fax : +48(0)22 56033-01**

**Konica Minolta (CHINA) Investment Ltd.** SE Sales Division  
SE Beijing Office  
SE Guangzhou Office

Shanghai, China  
Beijing, China  
Guangzhou, China  
Singapore  
Seoul, Korea

**Phone : +31(0)30 248-1200**  
**Phone : +49(0)511 7404-862**  
**Phone : +49(0)89 630267-20**  
**Phone : +33(0)1 493-82519**  
**Phone : +44(0)1908 540-622**  
**Phone : +39(0)23 90111**  
**Phone : +41(0)43 322-9800**  
**Phone : +46(0)31 7099464**  
**Phone : +43(0)1 87882-430**  
**Phone : +48(0)22 56033-00**  
**Phone : +86-021-5489 0202**  
**Phone : +86-010-8522 1551**  
**Phone : +86-020-3826 4220**  
**Phone : +65 6563-5533**  
**Phone : 02-523-9726**

**Fax : +86-021-5489 0005**  
**Fax : +86-010-8522 1241**  
**Fax : +86-020-3826 4223**  
**Fax : +65 6560-9721**  
**Fax : 02-523-9729**

**Konica Minolta Sensing Singapore Pte Ltd.**  
**KONICA MINOLTA SENSING, INC.** Seoul Office

Addresses and telephone/fax numbers are subject to change without notice. For the latest contact information, please refer to the KONICA MINOLTA SENSING Worldwide Offices web page (link below).

<http://konicaminolta.com/about/se/contact.html>